

Rubber Testing Solutions

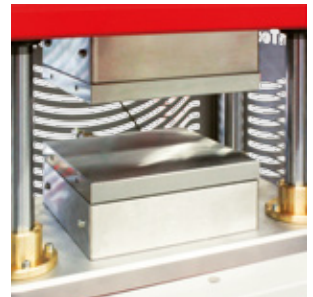

...Innovative testing solutions
made in Germany!

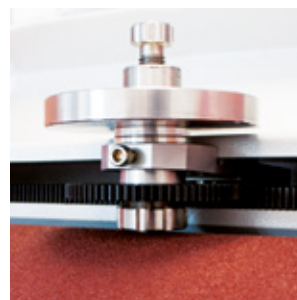



MONTECH'S RUBBER AND POLYMER TESTING SOLUTIONS AT A GLANCE

MonTech Werkstoffprüfmaschinen GmbH is the world's leading premium manufacturer of rubber testing instruments and laboratory solutions. Our extensive product range covers instruments for basic to high-end testing applications in quality control as well as research and development, integrated laboratory software systems, technical and calibration services as well as world-class application support and consulting.

MonTech testing solutions are engineered and manufactured entirely in Germany according to highest quality standards. Our products and services are available to customers in more than 53 countries worldwide with premier local support and assistance. All MonTech products are either available in standard configurations, or can be adapted and built according to individual customer requests and requirements.

MOVING DIE RHEOMETER & RUBBER PROCESS ANALYZER



4|5

MOONEY VISCOMETER



6|7

DISPERSION



8|9

HARDNESS & DENSITY



10|13

PLASTICITY



14

COMPRESSION SET



15

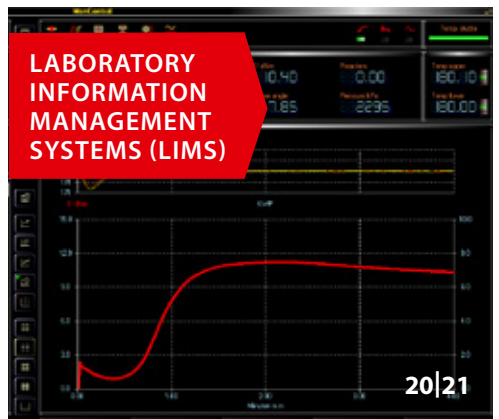
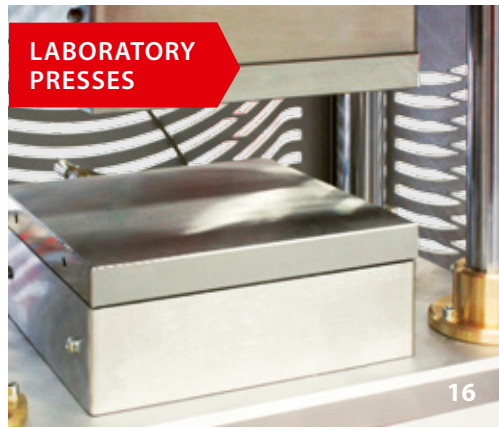
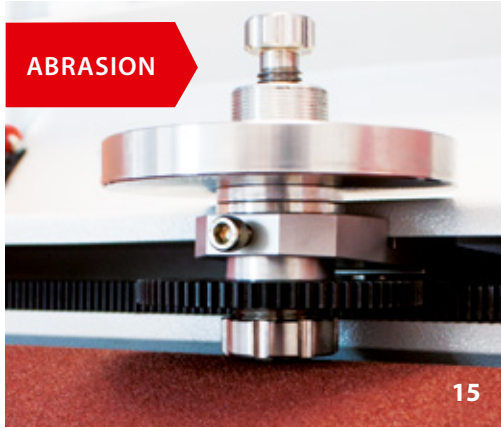

MOVING DIE RHEOMETER & RUBBER PROCESS ANALYZER SERIES



**MonTech Moving Die Rheometer
Rubber Process Analyzers**



Static Curemeters are designed to test mixed rubber compounds under isothermal test conditions with fixed strain and frequency to obtain cure properties including elastic, viscous and loss modulus, cure and scorch times. The software controlled instruments feature an integrated test specification management,

automated test scheduling and data acquisition as well as Pass / Fail result reporting. Dynamic Curemeters are Dynamic Mechanical Rheological Testers (DMRT) designed to measure material properties of raw elastomers or mixed rubber - before, during and after cure in a single test.



MDR 3000 Basic

Static testing

Compact, entry model instrument for the assessment of cure properties including elastic, viscous and loss modulus, scorch and cure times in quality control and simple R&D applications.



MDR 3000

Static testing

High-end instrument for advanced QC and static R&D testing for a broad range of materials (from LSR, all kinds of elastomers to composite materials) period at end to match others)



MDR 3000 Professional

Static and dynamic testing

Entry model instrument in the Rubber Process Analyzer (RPA) technology. The MDR 3000 Prof. can be operated either in static testing mode (MDR) or in dynamic testing mode (RPA).



D-MDR 3000

Static and dynamic testing

Top model for advanced dynamic testing of all kinds of rubber, rubber-like, curing or crosslinking materials. This includes TPE, TPV, LSR, Composite materials, Polyolefins, ...



D-RPA 3000

Static and dynamic testing

The D-RPA 3000 is truly the most advanced curemeter in the market with the highest compliance and accuracy for the most demanding static and dynamic testing to completely characterize polymers and rubber at all stages of manufacture.

INTERNATIONAL STANDARDS

ISO 6502

ASTM D 5289

DIN 53529

ISO 6502

ASTM D 5289

ISO 13145 / ISO 6502

ASTM D5289, D6204, D6601, D6048, D7050, D7605 / DIN 53529

ISO 13145 / ISO 6502

ASTM D5289, D6204, D6601, D6048, D7050, D7605 / DIN 5352

ISO 13145 / ISO 6502

ASTM D5289, D6204, D6601, D6048, D7050, D7605 / DIN 5352

OSCILLATION ANGLE

Mechanical drive:

$\pm 0.1^\circ, 0.2^\circ, 0.5^\circ$ (Std.) $1^\circ, 3^\circ$

Direct drive:

$\pm 0.1^\circ - 5^\circ$

Dynamic direct drive:

$\pm 0.01^\circ - 33^\circ$
 $\pm 0.01^\circ - 90^\circ$ (Optional)

Dynamic direct drive:

$\pm 0.001^\circ - 180^\circ$

Advanced dynamic direct drive:

$\pm 0.0001^\circ - 360^\circ$

OSCILLATION FREQUENCY

1.667 Hz

1.667 Hz

0.001 Hz – 33 Hz
(0.001 Hz – 50 Hz optional)

0.001 Hz – 100 Hz

0.001 Hz – 100 Hz

TEMPERATURE

Ambient to 232 °C

Ambient to 232 °C

Ambient to 232 °C

Ambient to 232 °C

Ambient to 232 °C

Automation options

Every MonTech Moving Die Rheometer and Rubber Process Analyzer can easily be automated with the widest and most reliable range of automation systems:

- Semi automation for automated film handling
- Linear automation for online testing with 5 or 10 samples capacity
- Tray automation with either 24, 48 or 100 samples
- Tray changer system for up to 240 or 480 samples

Instrument options

For specific testing requirements MonTech offers a variety of instrument options to customize a testing solution exactly for your specific requirements:

- Forced air and low-temperature cooling systems
- Axial force transducers
- Cavity pressure control systems
- High speed data acquisition systems
- Data, IT and software integration
- Advanced productivity options



MOONEY VISCOMETER SERIES



MonTech Mooney Viscometer

Mooney Viscometers are the backbone for testing the viscous flow of raw materials such as polymers and intermediates such as master-batches for maintaining stable and consistent manufacturing processes.

Furthermore, all MonTech Mooney Viscometers also allow Scorch, precise Stress Relaxation as well as Delta Mooney testing in accordance with latest international standards.



MV 3000 Basic

Static testing

Entry model instrument for repetitive Mooney Viscosity, Mooney Scorch and Stress Relaxation testing in quality control as well as R&D period at end to match others.



MV 3000

Static testing

Standard instrument for precise testing of Mooney Viscosity, Mooney Scorch and Stress Relaxation in accordance with international standards.



V-MV 3000

Static and dynamic testing

High-end instrument for QC as well as dynamic R&D testing with maximum flexibility featuring variable rotor speed and temperature sweeps as well as block programming with multi-step stress relaxation.

INTERNATIONAL STANDARDS

ISO 289:2005

ASTM D 1646

DIN 53523

BS 903: Part 58

AFNOR T43-00/005

BS 1673

GOST 10722-76

JIS K6300

TGL 25-689

ISO 289:2005

ASTM D 1646

DIN 53523

BS 903: Part 58

AFNOR T43-00/005

BS 1673

GOST 10722-76

JIS K6300

TGL 25-689

ISO 289:2005

ASTM D 1646

DIN 53523

BS 903: Part 58

AFNOR T43-00/005

BS 1673

GOST 10722-76

JIS K6300

TGL 25-689

ROTOR

Large and small sealed, with longlife seals

Large and small sealed, with longlife seals

Large and small sealed, with longlife seals

ROTOR SPEED

2 turns per minute

2 turns per minute

0 to 50 turns per minute, 0.01 steps

TEMPERATURE

Ambient to 232 °C

Ambient to 232 °C

Ambient to 232 °C



DISPERTESTER 3000

DISPERSION



DISPER TESTER 3000

DisperTester 3000 Carbon black dispersion tester

The DisperTester 3000 is an easy to use instrument for filler dispersion analysis providing superior reproducibility, compliance and repeatability. The instrument's precision telecentric optical system uses the reflected light method for obtaining high-resolution reflective images from the sample surface. This design paired with the MonDispersion software provides the user with accurate, repeatable results in seconds, including X, Y and Z value as well as % Dispersion and white area analysis. The DisperTester 3000 can be used with cured and green rubber compounds and already comes with built in reference scales in accordance with ISO 11345 and ASTM D 7723 standards.



DISPER TESTER 3000 PLUS

DisperTester 3000 plus Advanced Carbon black dispersion tester

The DisperTester 3000 plus is the latest generation of reflected light dispersion testers offering new and unique features:

- Rugged aluminum housing machined from a single block of aluminum
- 10 Megapixel camera with USB 3.0 connectivity
- Multi-direction variably controlled LED light sources
- Precisely guided, horizontally moving camera system to obtain multiple test points from a single sample placement
- Fully automated or manual focusing, scanning and evaluation
- Possibility to test black, white and colored rubber compounds
- Integrated data analysis with PDF reports, histograms and high resolution result images
- Optional 50 samples autoloading system





DISPERCUT 3000

Stretched sample cutter for Dispersion testing

The DisperCut 3000 is the most accurate and effective way for preparing fine cut samples of cured and uncured rubber for dispersion testing applications. The sample is stretched while cutting to avoid any smearing or contamination of the cut surface. Precise sample cuts can be prepared in less than a second. For highest operator safety, the unit is fitted with two hand safety operation with anti-tiedown as well as automatic knife cover.



DISPERCOOL 3000

Test sample conditioning and freezing unit

The DisperCool 3000 is used for deep-freezing test samples to about glass-transition temperature prior to sample cutting. This patented system is specifically designed for Dispersion Testing to ensure a perfect test sample preparation and highest quality of the samples surface area.

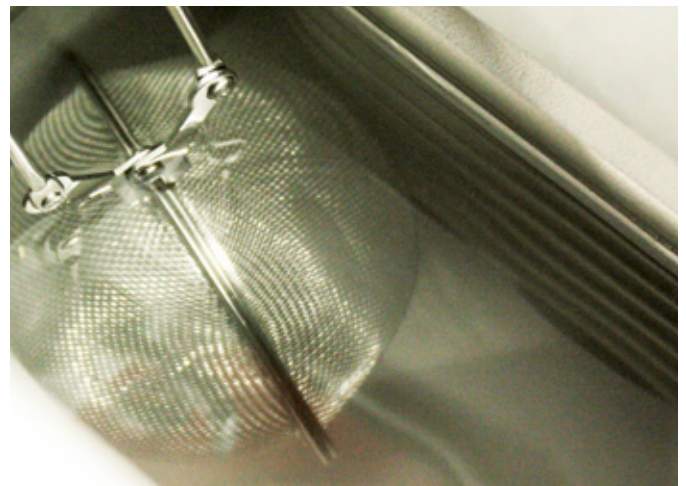

DM 3000

DENSIMETER

DENSIMETER DM 3000

The MonTech DM 3000 is a semi automated Densimeter. The compact instrument is designed for rapid and accurate determination of specific gravity. Up to 4 tests per minute can be performed with simple, software guided operation. The Densimeter utilizes the hydro-static method by comparing the weight of the sample in air as well as in an immersion liquid. The DM 3000 is equipped with a precision analytical balance guaranteeing highest accuracy and repeatability. This balance may be used separately for other weighing applications.

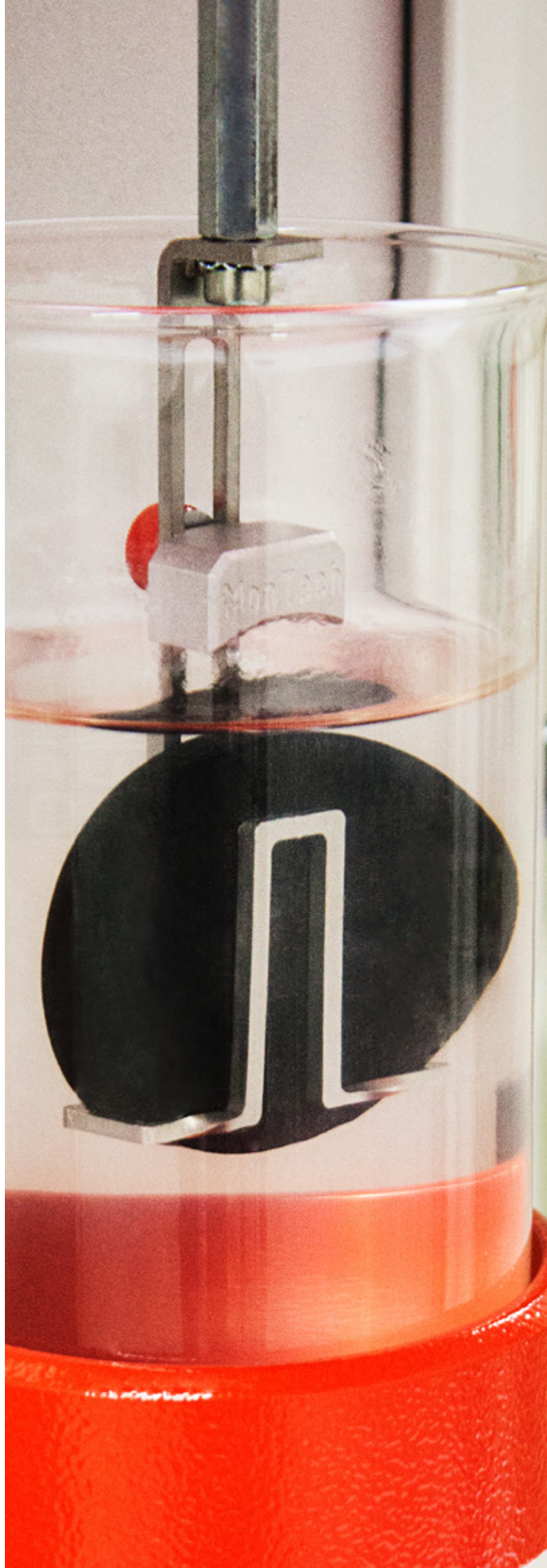
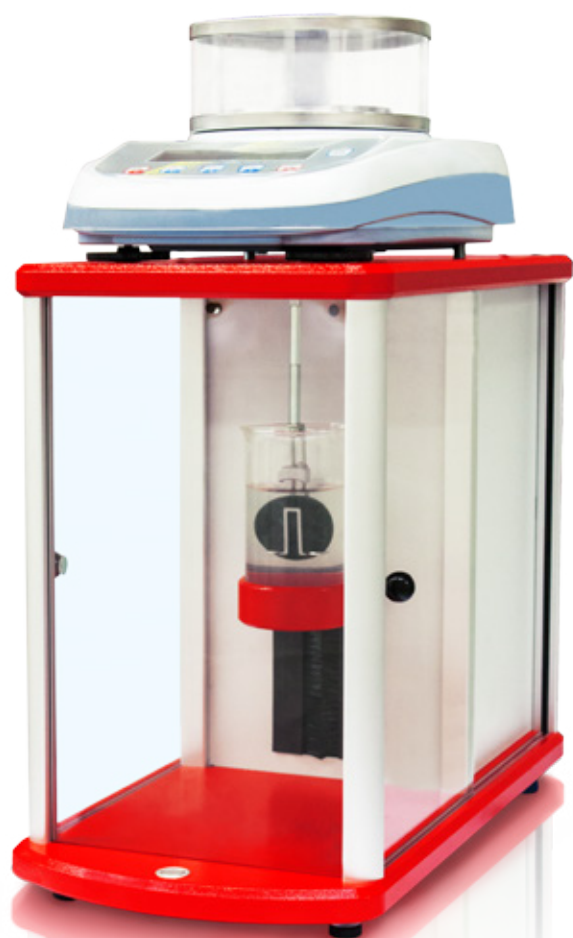

HT 3000

HARDNESS TESTER

RUBBER HARDNESS TESTER SERIES HT 3000

Hardness (resistance to indentation) is one of the most important properties of rubber products and parts. MonTech therefore offer a full range of handheld and benchtop precision hardness testers according to various scales and standards.

This includes devices according to

Shore: A, A0, B, C, D, D0, E, 00, 000, 000S,

IRHD: M, H, N, L, VLRH

Asker: C, CS

Of course all required accessories such as test stands, auto-samplers, centering and positioning devices as well as reference and test blocks are also available.

Most popular products from the HT3000 family include:

- **HT 3000 - A**
Digital handheld Shore A precision hardness tester
- **HT 3000 - D**
Digital handheld Shore D precision hardness tester
- **HT 3000 - S**
Test stand with pickup arm and integrated loadweights
- **HT 3000 - SA**
Automated test stand with automated indentation movement
- **Accessories such as**
 - Auto-samplers
 - Centering and positioning devices
 - Verification and control rings
 - Reference rubber blocks
 - Additional loadweights
 - Software systems
 - ...

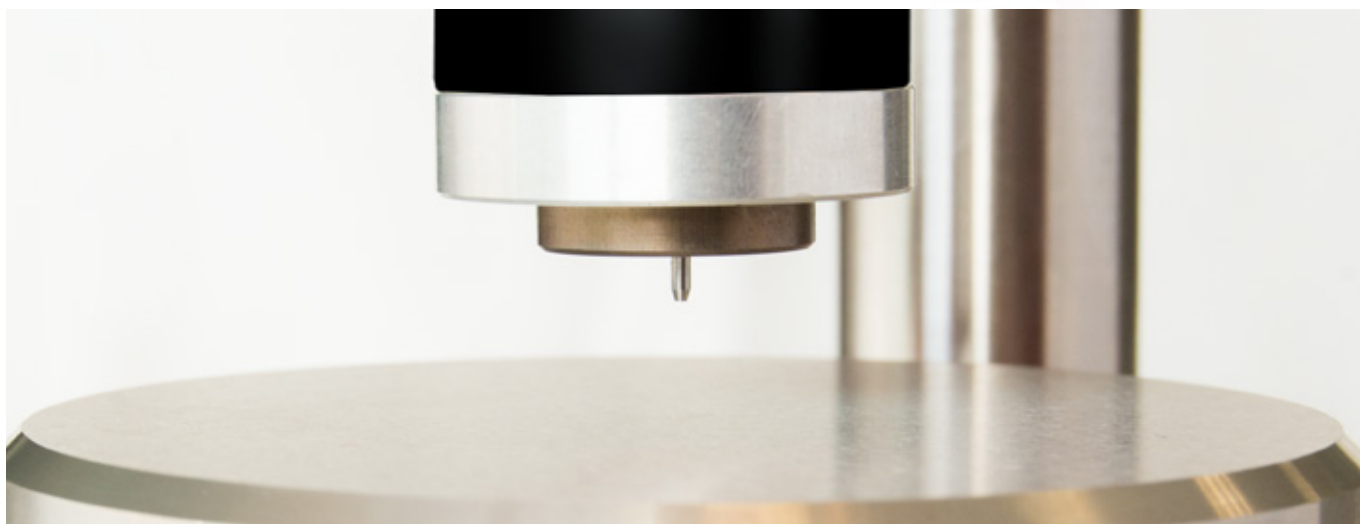

H&D 3000

AUTOMATED HARDNESS & DENSITY TESTER



H&D 3000

Automated Hardness and Density testing instrument

The H&D 3000 combines two important tests in a single instrument: Hardness and density are simultaneously measured on cured rubber discs. The instrument is completely software programmable for fully automated and unattended sample processing from a 20-position sequential rotary tray. Up to 5 individual Shore A hardness readings can be taken on each sample - afterwards the weight of the sample

in air as well as in a temperature compensated immersion liquid is taken. Finally the reliable measured hardness and specific gravity test results, median and mean values as well as Pass/Fail status are automatically calculated and reported.



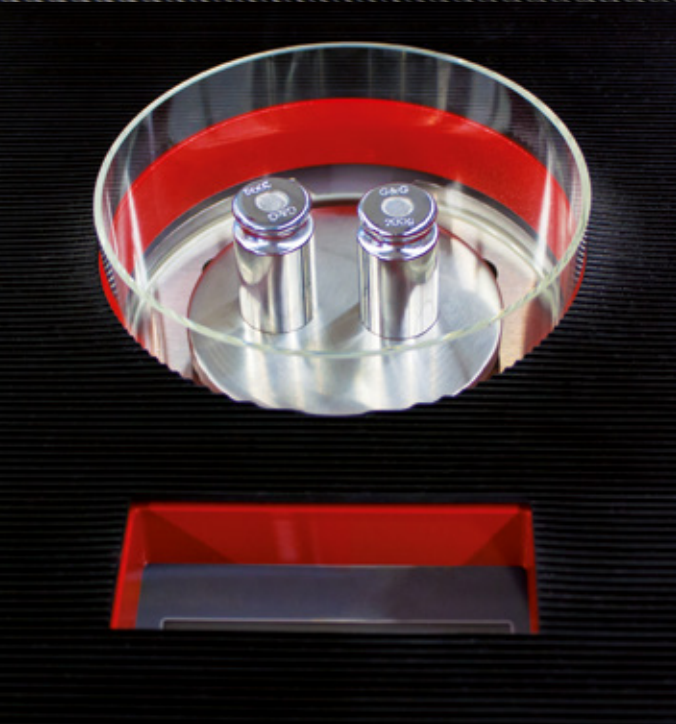
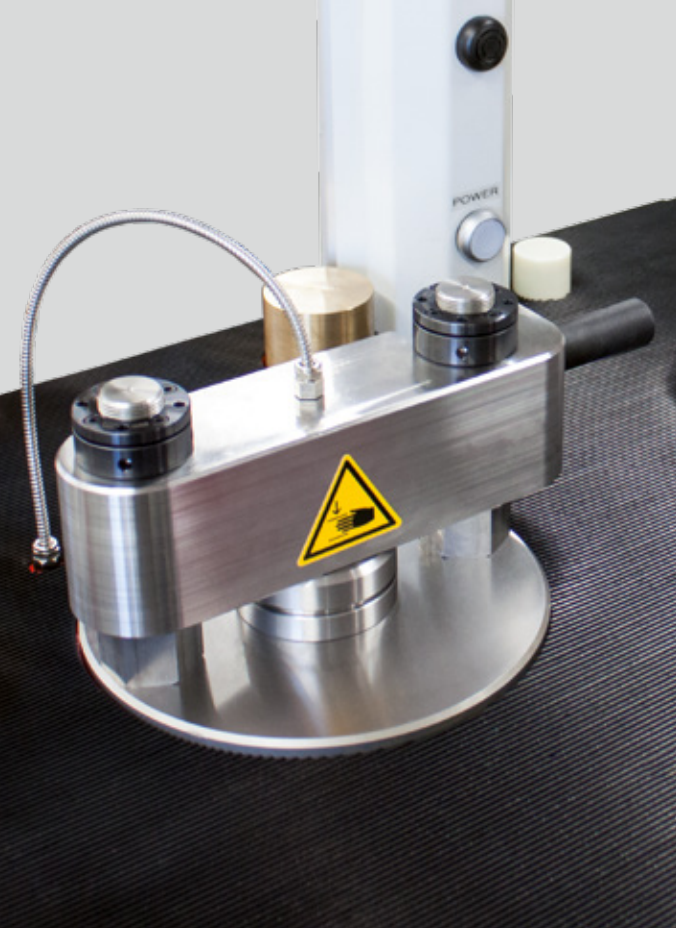

RD 3000 COMPRESSION DENSIMETER



RD 3000

Compression Density Tester for uncured rubber compounds and raw materials

The RD 3000 compression density tester provides a simple and convenient way to determine the density of raw polymers, master-batches and uncured rubber compound specimens of any shape or geometry. The instrument features an integrated precision scale for accurately measuring the weight of the specimen. In a second step, all air trapped in the sample is removed by compressing the material in a massive barrel - once stabilized - allows the volume to be determined. Once the test sequence is finished the density is automatically calculated and displayed on the integrated touchscreen. Optionally the instrument can be controlled and test results can be remotely acquired by the MonDevice software system.

RP 3000 & AO 3000

RAPID PLASTIMETER SERIES



RP 3000

Rapid Plastimeter for Polymers and Natural Rubber

The MonTech Rapid Plastimeter measures the plasticity, flow and viscosity of polymers and unvulcanized rubbers. The instrument is typically used in conjunction with the MonTech Ageing oven AO 3000 for plasticity testing to determine the Plasticity Retention Index (PRI) of raw natural rubbers.

The variable temperature range from 25°C to 200°C along with freely programmable conditioning and load times allow a convenient characterization of the flow behavior of natural and synthetic rubbers at variable test conditions. For some applications, this method offers a quick, low cost alternative to a Mooney Viscosity test.

The instrument is supplied in a complete set along with a tabletop, mechanical volumetric specimen cutter for a reliable preparation of test specimens. The instrument can be equipped with the optional MonPlast computer software for fully automated test management, PRI calculation and reporting.

PLASTICITY RETENTION INDEX (PRI):

PRI is a measure of the resistance of raw natural rubber to oxidation. This effect is assessed by measuring the plasticity before ageing (P_0) and after ageing for 30 mins at 140°C (P_{30})

$$PRI = \left(\frac{P_{30}}{P_0} \right) \times 100$$



AO 3000

Ageing oven for Plasticity Testing

The MonTech ageing oven for plasticity testing ages rubber in accordance with international testing standards. In conjunction with the MonTech Plastimeter, it allows the user to determine the Plasticity Retention Index (PRI) of raw natural rubbers.

KEY FEATURES:

- Precise temperature control to $140 \pm 0.2^\circ\text{C}$
- Digital temperature display
- Four chambers with four dishes each with independent timers
- Stability check and overheat protection



CS 3000

COMPRESSION SET FIXTURES

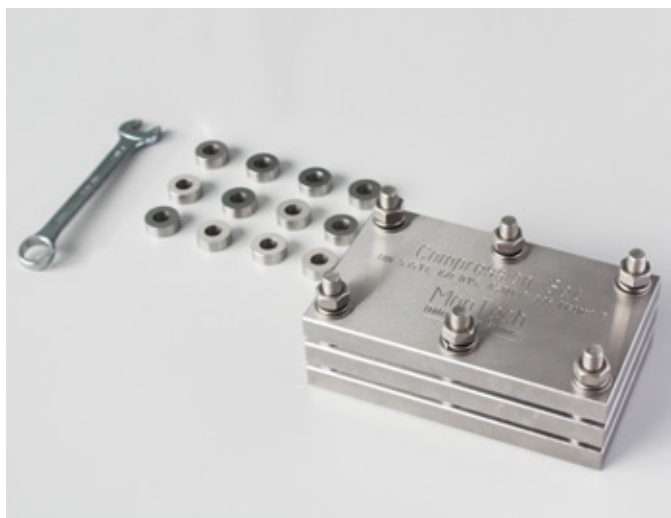

CS 3000

For compression set testing according to ISO 815, DIN 53517, ASTM D395 and other International Standards, the CS 3000 compression set fixtures enable measurements of a rubber compound's ability to return to its original thickness after prolonged compressive stresses. As a rubber sample is compressed to a predefined percentage between 2 flat parallel plates and kept for a specific time at a certain temperature, it loses its ability to return to its original thickness. This loss of resiliency, also called memory or permanent set, characterizes the capability of an elastomeric product to perform over a long period of time.

MonTech compression set fixtures are entirely made of precision ground stainless steel and feature stiff compression plates as well as sets of spacers according to customer choice. Optionally suitable tempering oven and height gages are available.

ABR 3000

ROTARY DRUM DIN ABRASION TESTER

The MonTech ABR 3000 abrasion tester is a tear testing instrument for determination of an elastomer's resistance to frictional loss, using a rotating or fixed specimen in accordance with DIN 53516 and DIN ISO 4649. The test specimen is fixed into a quick clamp sample holder and precisely guided - either with or without rotation - over a predefined distance of either 20 or 40 Meters, with a defined load on a sheet of abrasive paper mounted to a stainless steel rotary drum of 150 mm diameter. Finally, the frictional loss is calculated by comparing the sample weight before and after testing.

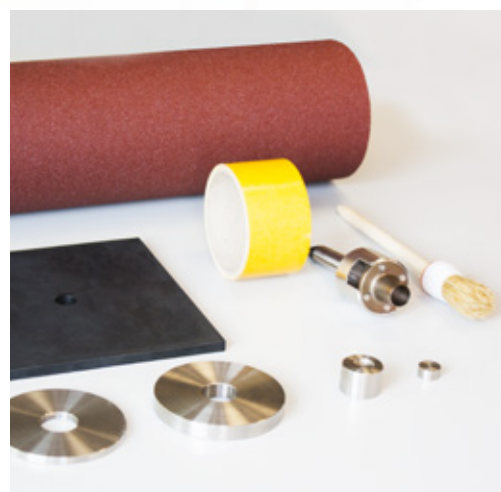
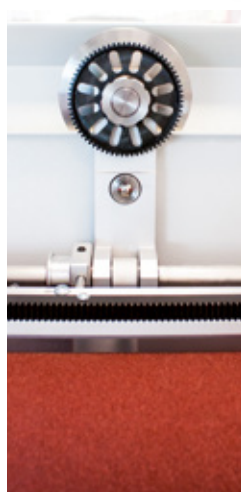
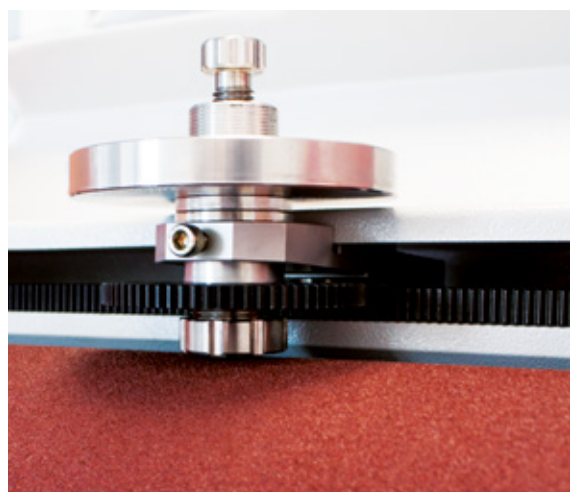

LP 3000

HYDRAULIC LABORATORY PRESS SERIES



Hydraulic laboratory press series LP 3000

Hydraulic laboratory press series LP 3000 offers the highest accuracy and performance in rubber sample curing. All MonTech laboratory presses are in full compliance with ISO 2393 and other applicable international standards, featuring press forces of $>3.5\text{MPa}$, an overall temperature accuracy of $\pm 0.5^\circ\text{C}$ and a platen parallelism of better than 0.1mm/m . The four-column hydraulic LP 3000 series presses are available in 4 different sizes, with platen dimensions ranging from $196 \times 196 \text{ mm}$ to $496 \times 496 \text{ mm}$ and maximum press forces of 20 to 100tons.

- **LP 3000 – 200kN**
Small size benchtop hydraulic laboratory press
- **LP 3000 – 400kN**
Floorstanding hydraulic laboratory press
- **LP 3000 – 600kN**
Heavy duty hydraulic laboratory press for routine moulding applications
- **LP 3000 – 1000kN**
High capacity hydraulic laboratory press for demanding and large-scale applications

Precision laboratory sample curing moulds

MonTech curing moulds are precisely made of tempered stainless steel, precision ground and finished - of course fully compliant with ISO, DIN, ASTM and GB Standards. Moulds are available in standard sizes and custom designs also can be manufactured in accordance to customer specific requirements.

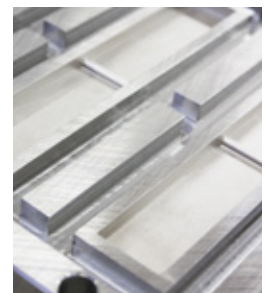

FT 3000

DYNAMIC FATIGUE TESTER SERIES

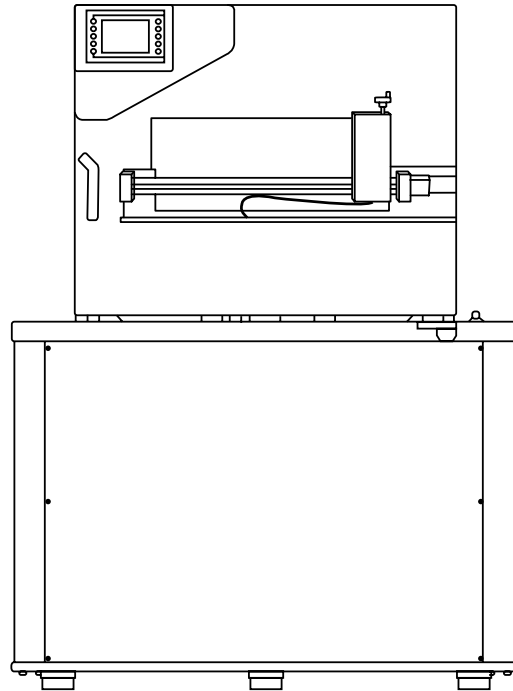

State of the art fatigue testing and lifecycle simulation instrument

The FT 3000 is a high-end, direct linear drive fatigue tester for tension and bending fatigue (De-Mattia) testing to determine fatigue life and flex cracking/crack growth properties in accordance with:

- ISO 132, 6943,
- ASTM D 430-B,
- ASTM D 813,
- DIN 53 522 -1/2/3.

The instrument is designed for continuous operation in applications such compound and material development as well as in-process quality control in rubber plants and other areas requiring dynamic testing of rubber samples.

Especially due to the unique advanced linear motor design and optional CCD camera data acquisition system, the machine can easily be custom designs and adapted to individual customer testing needs.



VS 3000

VOLUMETRIC SAMPLE CUTTERS



Cutting of uncured specimens and preforms

R-VS 3000

The R-VS 3000 Rheometer sample cutter is designed for the fast, safe and easy preparation of Rheometer test samples with a constant sample volume, significantly reducing operational variability and increasing test result reproducibility.

M-VS 3000

The M-VS 3000 Mooney volumetric sample cutter enables higher accuracy, repeatability and optimized testing results in Mooney Scorch and Viscosity testing by preparing test samples with a constant volume. The M-VS 3000 also features automatic cutting of a center hole for the rotor shaft along with a time delay for compressing the material before cutting.

VS 3000

The VS 3000 universal constant volume cutter is the ideal and reliable sample preparation tool for applications that require constant volume samples such as preforms for moulding operations.

The VS 3000 sample cutter can be fitted with knives of any diameter between 20 and 60mm per customer requirements, making the cutter an ideal tool for easy preform preparation in lab or production environments.



P-VS 3000

DIE CUTTERS FOR SPECIMEN PREPARATION



P-VS 3000 UNIVERSAL SAMPLE CUTTER SERIES

Universal sample cutter for fast and precise preparation of sample test specimens for tensile tests and all other DIN, ISO and ASTM standard sample shapes from rubber, elastomers, foam rubber, plastic films, foils and paper.

Any type of cutting knife can be used with the P-VS 3000 sample cutter. Knives can be changed in seconds and cutting height can easily be adjusted on the upper piston ram.

- **P-VS 3000 M** Manual lever arm type cutter
- **P-VS 3000** Standard pneumatic die cutter
- **P-VS 3000 15kN** High force pneumatic die cutter

UNIVERSAL SAMPLE CUTTING KNIVES AND DIES

MonTechs range of cutting knives and dies are durable and built to last, machined from a solid piece of steel, precision ground and hardened. MonTech cutting knives guarantee optimal dimensional stability, form accuracy and a long lifetime. All ISO, ASTM, DIN, GB and types according to other international standards are readily available.



CP 3000

THE INNOVATIVE TABLETOP LABORATORY BALE CUTTER

CP 3000

The laboratory bale cutter CP 3000 provides the most convenient solution to cut and slice polymers bales, blocks and rubber sheets. Fitted with a two-hand safety operation system, optional automatic knife cover and feeding tunnel the unit provides utmost operator convenience meeting highest safety standards.

The CP 3000 is available in two different sizes:

- CP 3000 Standard with a cutting width of 520mm
- CP 3000 Compact with a cutting width of 285mm



MonControl & MonStat

INTEGRATED SOFTWARE SYSTEMS



MONCONTROL

Analyses Software for testing instruments

MonControl - the most easy-to-use and versatile instrument control software. MonControl provides the most versatile platform for managing your laboratory and testing data, from a single machine with remote MonView data viewers for office clients, to multi-machine integrated laboratory systems. Flexible programming, simple instrument control and fully automated data acquisition and processing make MonControl a stable software solution to count on every day. Whether static or dynamic testing, MonControl already comes with preloaded test routines for most standard industrial applications and test sequences according to international standards (ISO / ASTM / DIN), allowing even new or untrained users to start testing within minutes.

DESIGNED FOR

- Rheometers (MDR/ODR/RPA)
- Mooney Viscometers
- Rebound testers
- Hardness testers
- Abrasion testers
- Density testers
- Processability testers
- Tensile testers
- Balances / Scales
- ...

MONSTAT

Statistical Process Control (SPC) Software

Statistical Process Control Software helps to quickly reduce variations and costs as well as productivity. MonStat is a dynamic and adaptable software for SPC featuring both realtime and historical data analysis to help you to improve product quality as well as understand and optimize manufacturing processes. MonStat offers powerful analytical techniques by joining data retrieved from LIMS database systems with data collected from production machinery on the shop floor, transforming it into actionable quality information.

AVAILABLE CHARTS

- Attributes control charts
- Variables control charts
- Histograms
- Spreadsheets and data tables
- Pareto bar charts
- Multi-line, type or source charts
- ...

MonQuality & MonRecipe

LIMS AND COMPOUNDING SYSTEMS

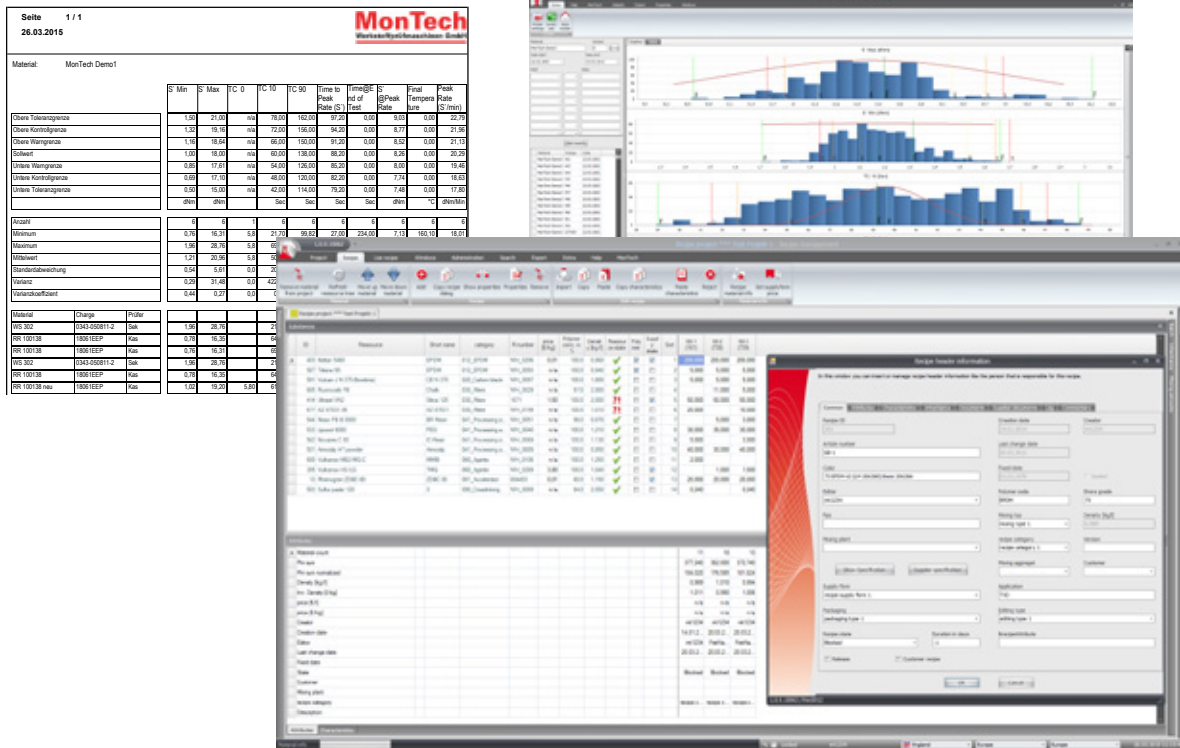

MONQUALITY

Laboratory Information Management System LIMS

MonQuality has been designed to help you to meet all your information management objectives, manage all your complex lab processes and provide exactly the information needed, at the right time and in the right format. MonQuality's flexibility is manifested in multiple levels of the system, from automated workflow and records management to closed-loop traceability.

Developed specially for the rubber and polymer industry, providing unique features such as full multi-site collaboration capabilities, remote data access and customized reporting, MonQuality LIMS truly is the ideal software platform for your laboratory.

KEY FEATURES

- Version controlled management of test specifications, preparation and ageing methods, sampling, ...
- Status of every lab order can be retrieved in seconds
- Customer depended specifications and testing
- Full traceability of all activities in the lab
- Full support of complex test sequences and workflows
- Direct, bi-directional communication with lab devices from MonTech or other manufacturers

MONRECIPE

Software for Compound and Material management

MonRecipe was specifically designed for formulation and compound development needs in the rubber industry. This unique software system helps you to create, cost, maintain and modify complex formulations quickly and easily with unprecedented version control, allowing you to streamline your formulation process along with speeding up and reducing the cost of bringing new products to the market. MonRecipe is the dynamic workbench for your recipe ideas, allowing you to experiment and manage multiple scenarios for even the most complex recipes with the ability of a simultaneous optimization of raw material and process cost for true value engineering.

KEY FEATURES

- Precise management of all raw materials, development projects, compound recipe specifications and versions
- Integrated search function easily retrieves recipes and data matching requirement specifications
- Possibility to define and use customized material data sheets, recipes and mixing protocols
- Multi-stage normalization of recipe ingredients
- Customizable recipe attributes, nominal and set values with full incorporation of trial mixing and test result data
- Single-click export in all typical formats (XLS, PDF, JPG, ...)

INSTRUMENT UPGRADES AND REBUILDS

MonTech has designed specific programs to answer every customer's instrument needs and budget and guarantee the highest instrument performance.

→ REPAIR, REBUILD AND UPGRADE

Heavily used instruments that are worn or have suffered severe damages can easily be repaired on-site or in one of our local MonTech workshops. At the same time, instruments can be upgraded to PLC-based controller technology with digital data acquisition and the latest software systems.

→ CONVERT

Convert your instrument to adapt it to your evolving testing needs while bringing your testing operation up-to-date and in compliance to the latest standards and technologies e.g. by converting your ODR to an MDR, providing significantly better accuracy and reproducibility, a much easier instrument operation and a higher productivity

→ EXCHANGE

Exchange your instrument for another already upgraded and rebuilt instrument available from stock at many MonTech locations.

→ TRADE IN

Trade in your used instrument(s) towards the purchase of a new instrument.



QUALITY PRECISION TESTING FILM FOR SIMPLIFYING INSTRUMENT OPERATION AND INCREASING EFFICIENCY

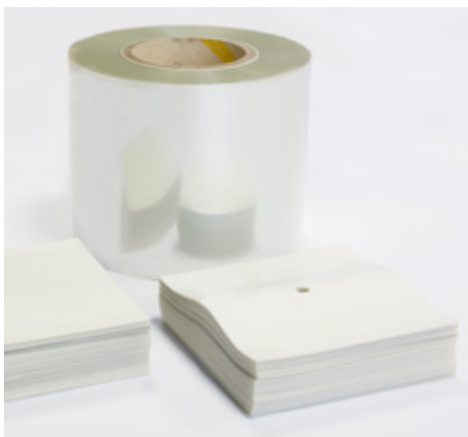

MonTech advanced testing films have been precisely developed and are typically used for Rheometers, Mooney Viscometer testing applications as well as cure wrapping and various laboratory compression moulding applications. Testing film is highly recommended in order to protect dies, seals, seal plates and moulds from test material contamination and wear, minimizing the need for cleaning, increasing the lifetime of major components such as seals and extending calibration as well as maintenance cycles.

The scope of testing films includes various types, grades and thicknesses made from Polyester, Polyethylene, Nylon, Kapton or Kevlar. Of course any type or grade of film can be tailored to specific shapes, dimensions or forms of supply, specifically tailored to your demand and application. MonTech therefore keeps an extensive stock of almost any type and grade of film ensuring shortest delivery times on even customer specific forms or sizes.

WORLDWIDE SERVICE & SUPPORT

MAINTENANCE AND CALIBRATION



Global customer support

Customer orientation is our top priority. That is why we are active on your behalf worldwide with one aim: to provide first-class service and support throughout the entire life-cycle of your instrument. Whenever our customers need help of any kind, we are at their service! Therefore, we are available 24 hours a day, 365 days a year worldwide.



Remote and emergency support

Our remote and tele-support provides help and support whenever it might be needed. Whether you might have questions on specific instrument applications, test setups, test executions, results, calibrations, correlations or diagnostics and troubleshooting, our superb team of technical and application specialists is only a quick phone call away.



Service, maintenance, calibration

MonTech provides fully traceable calibration services using the latest equipment and methodology by highly skilled field service engineers, keeping your instrument in perfect shape. All work and calibration procedures are fully in compliance with ISO, ASTM, DIN and other applicable standards, proven by our ISO 9001 certification and ISO 17025 accreditation. This allows us to offer a huge scope of mechanical, dimensional, thermal and many other calibrations wherever your laboratories might be located.

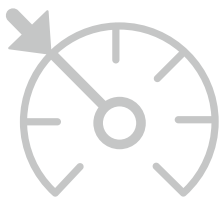

Single source ISO 17025 calibration services

MonTech's on-site calibration service provides ISO 9001 certified and ISO 17025 accredited field calibrations to any brand, type or model of rubber testing machinery or lab equipment. These on-site service visits and calibrations are designed to be fast and reliable with minimum down time.

MonTech employs a global team of the most qualified field service engineers, strategically positioned for cost-effective service wherever calibration services or assistance may be needed.

CONTACT US AT

info@rubber-testing.com

www.rubber-testing.com



Quality Management

We are certified

Regular voluntary monitoring according to **ISO 9001:2008**



Deutsche
Akkreditierungsstelle
D-PL-11292-01-00
ISO 17025:2005

Rubber Testing Solutions

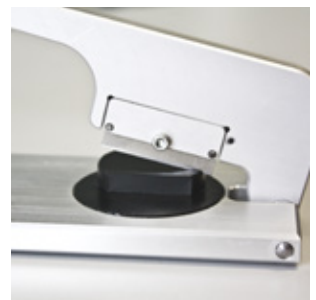
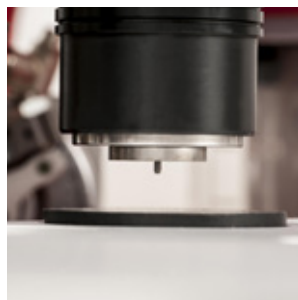
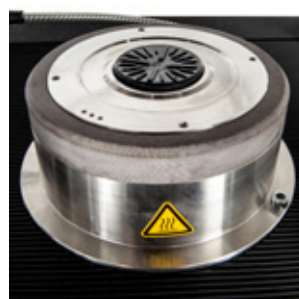
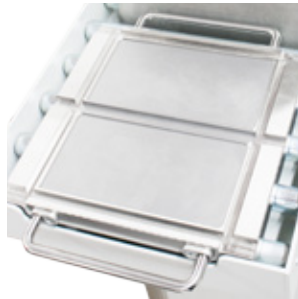
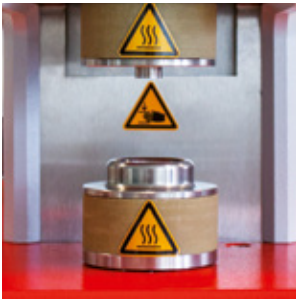

MonTech
Werkstoffprüfmaschinen GmbH
Carl - Benz - Straße 11
D - 74722 Buchen / Germany

Phone: +49 (0)6281 562230
Fax: +49 (0)6281 562255
info@rubber-testing.com
www.rubber-testing.com

